

Solo com capacidade de suporte > 2.50 kgf/cm²
Solo compactado sobre a sapata
peso específico > 1600.00 kgf/m³

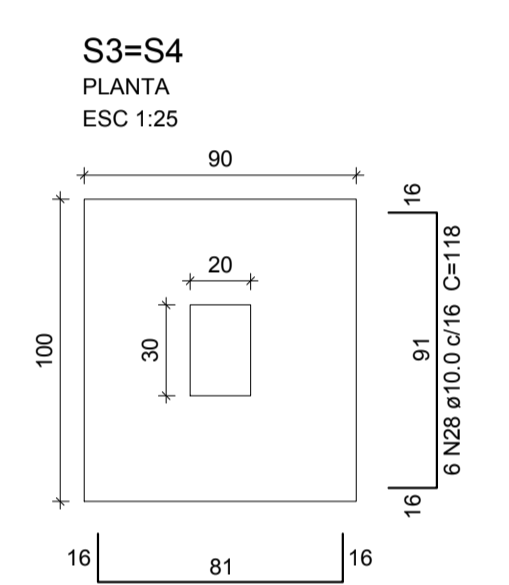

Solo com capacidade de suporte > 2.50 kgf/cm²
Solo compactado sobre a sapata
peso específico > 1600.00 kgf/m³

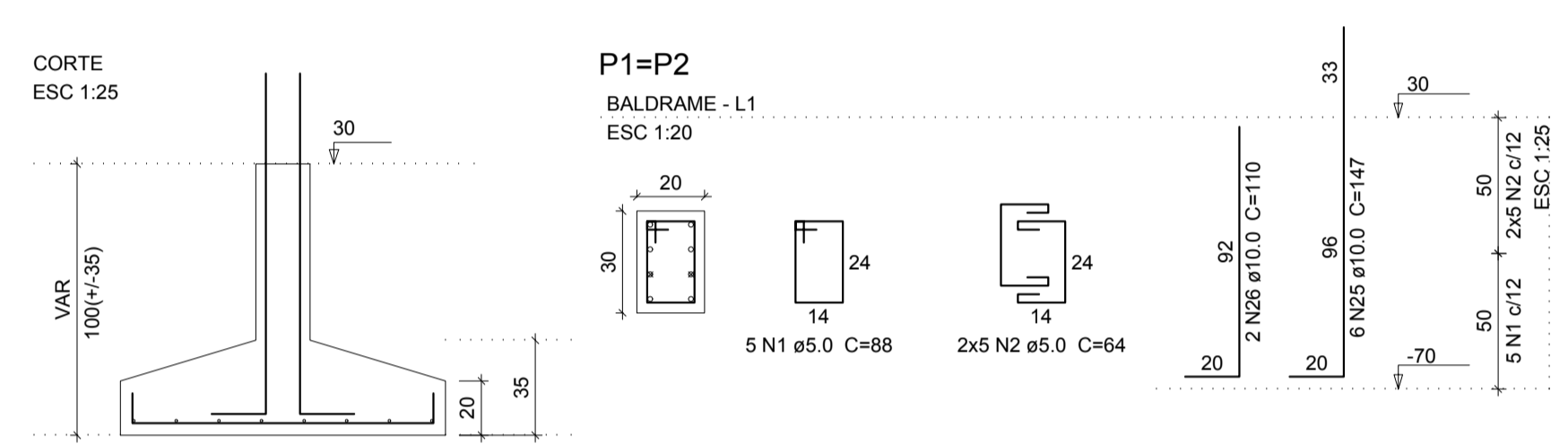
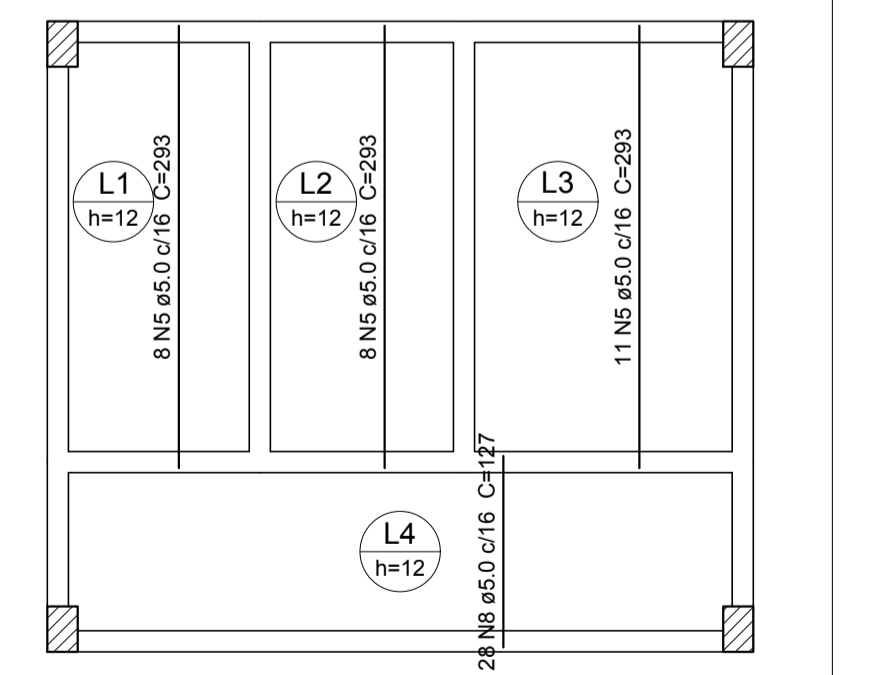
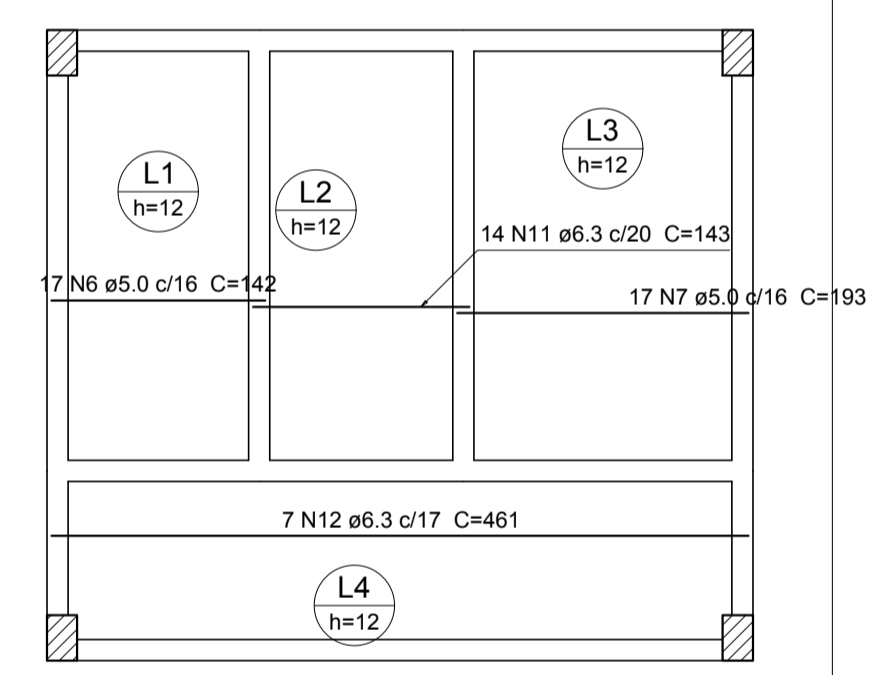
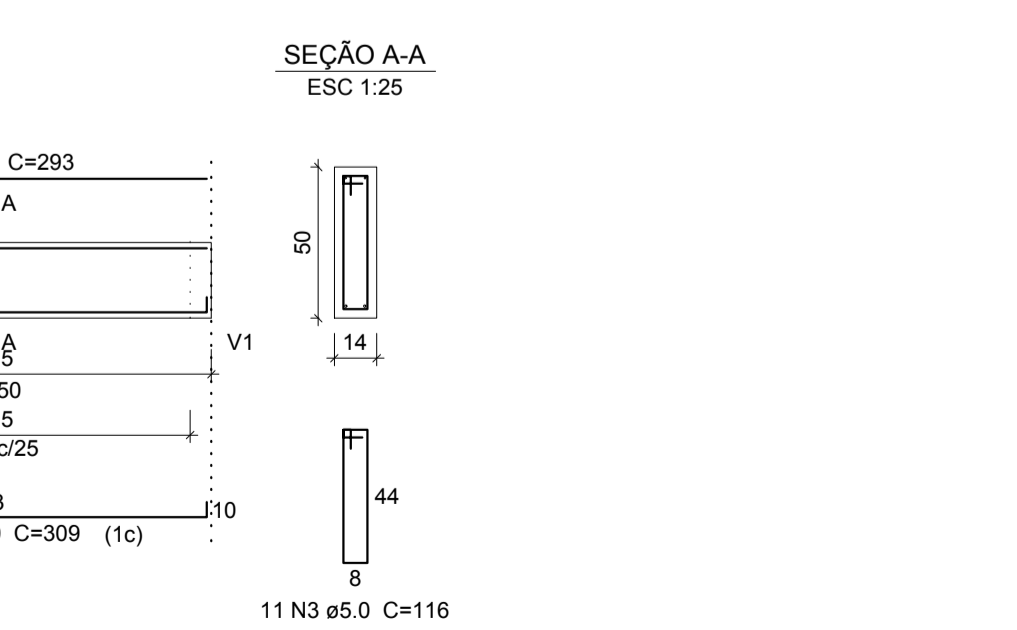
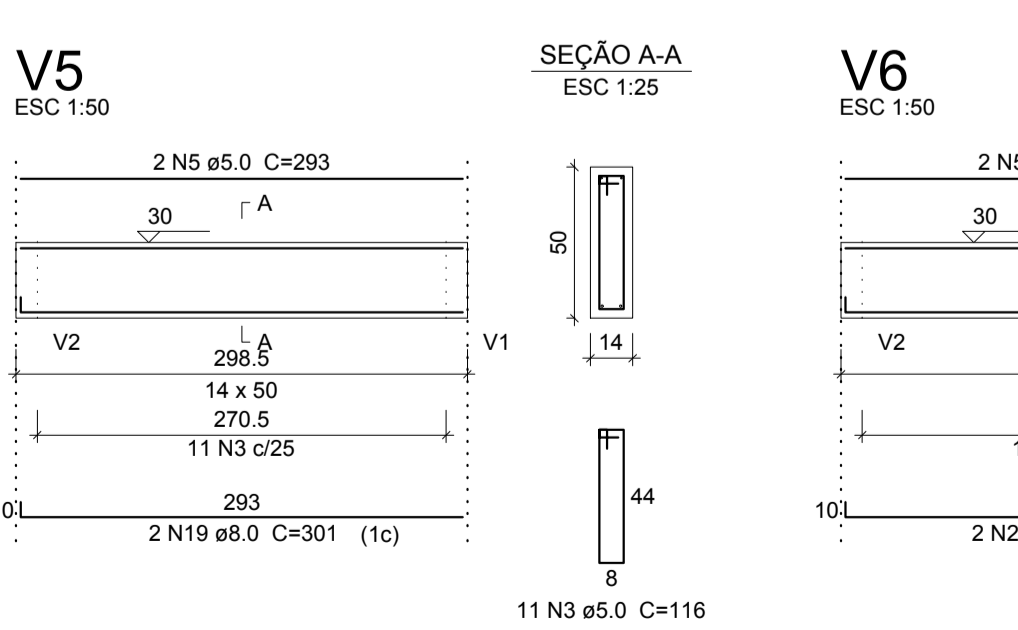
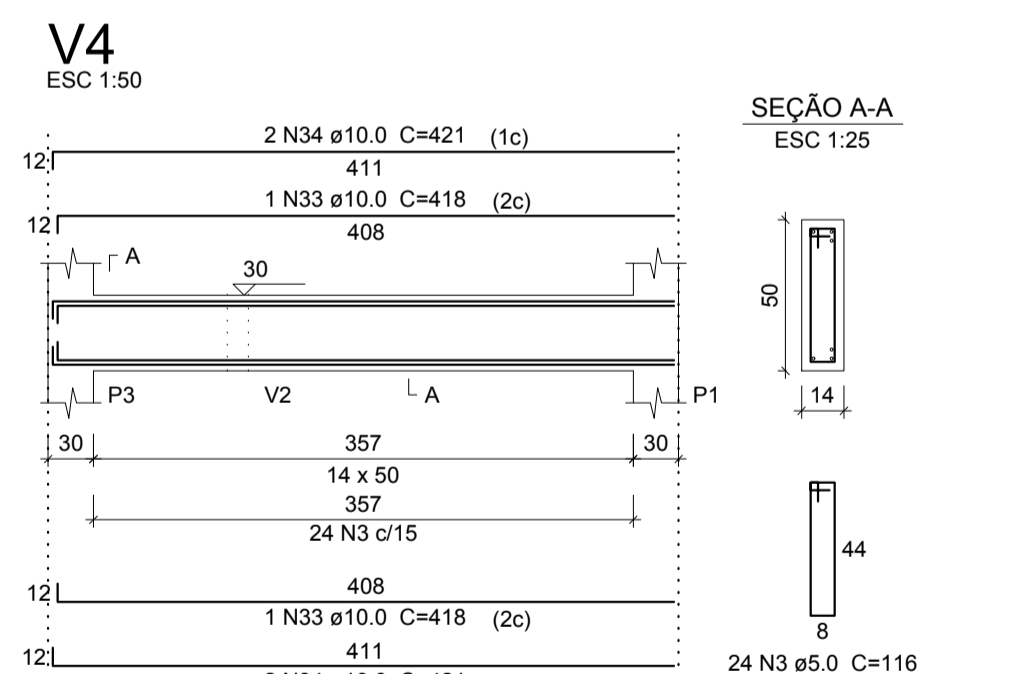
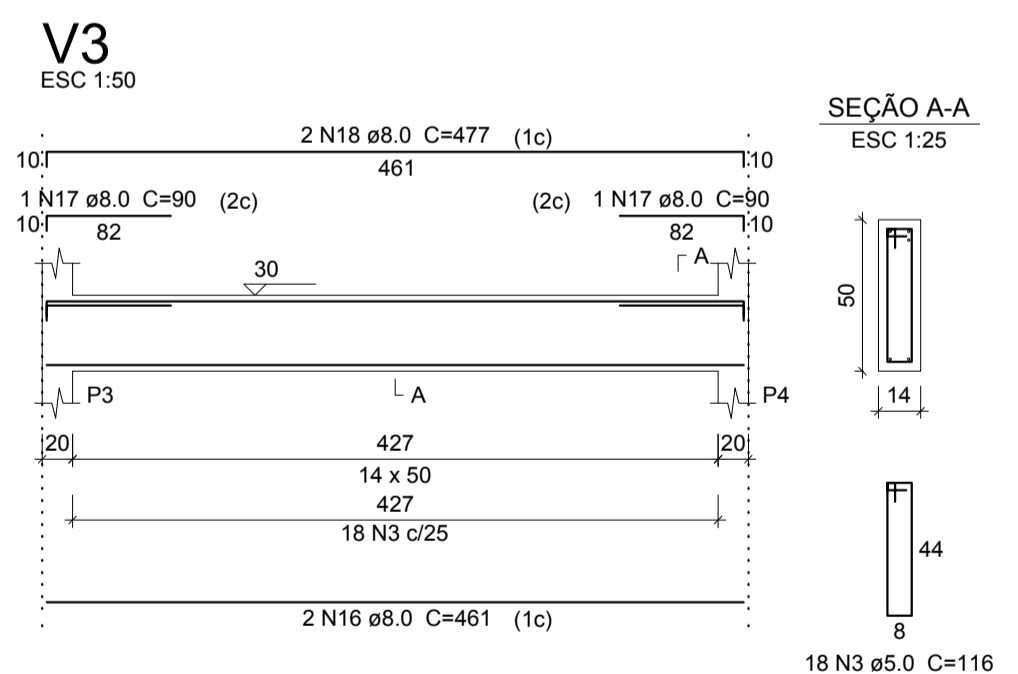
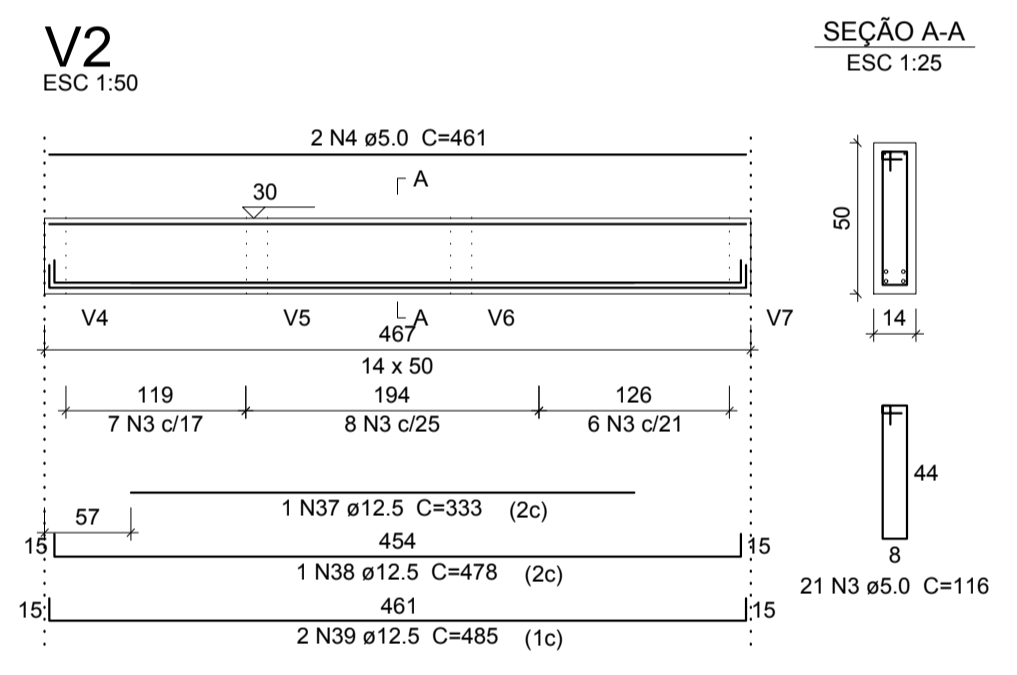
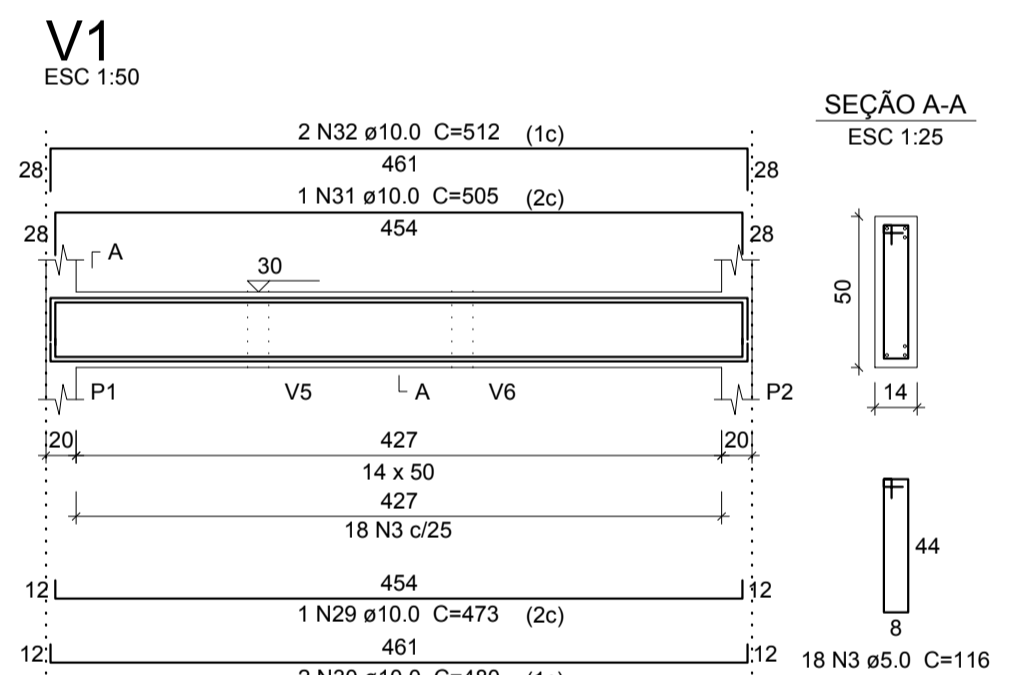
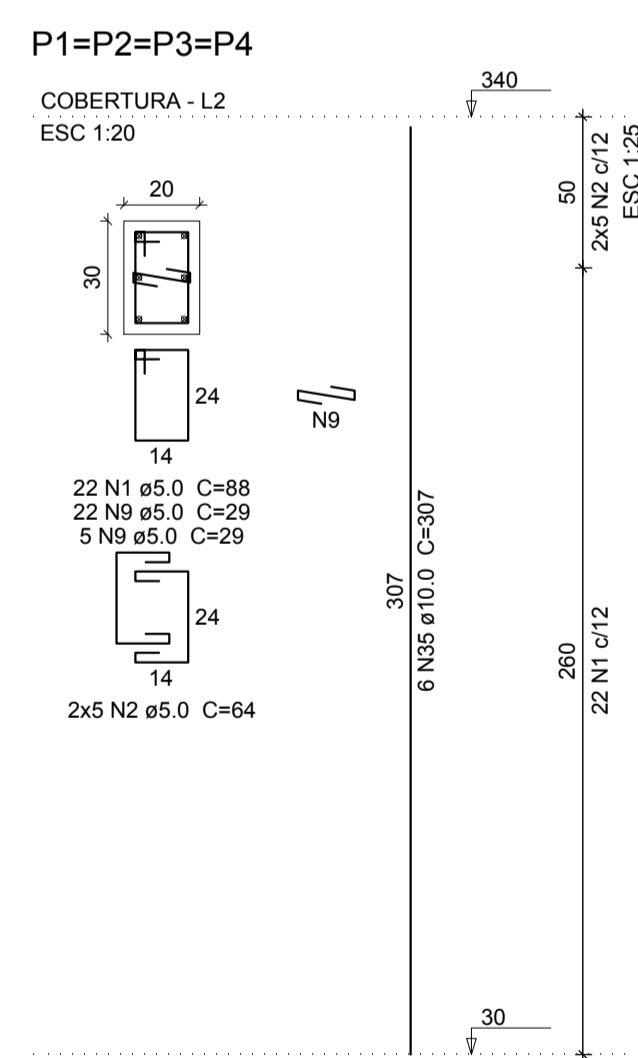
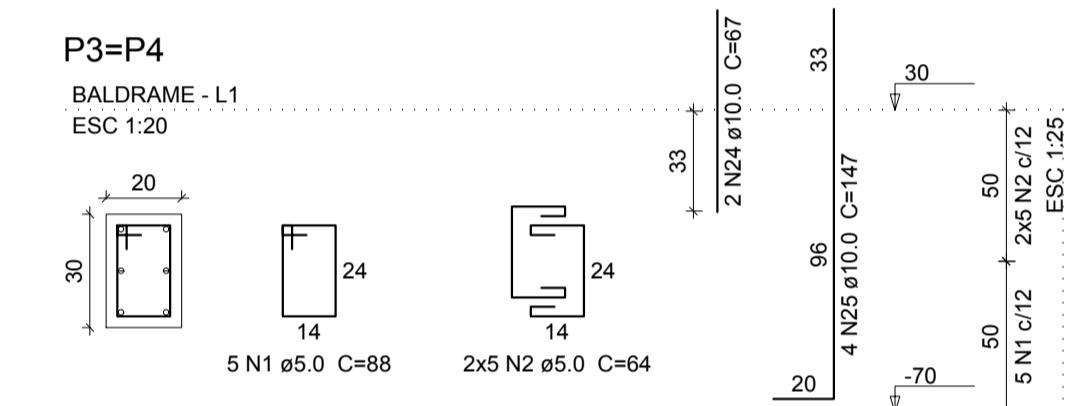
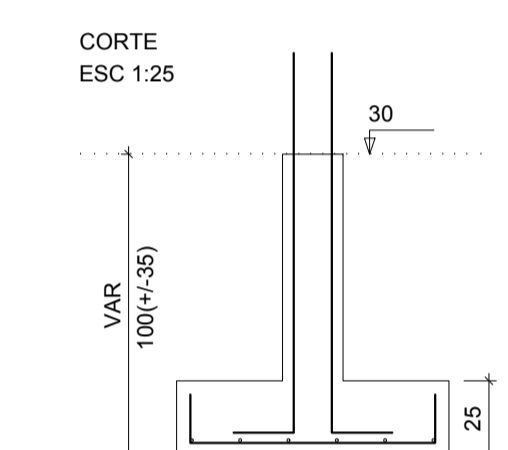

Armação positiva das lajes do pavimento Baldrame (Eixo X)
escala 1:50

Armação positiva das lajes do pavimento Baldrame (Eixo Y)
escala 1:50